

Data Sheet



Article number: 20611230

Description: E+G indexing mechanism
GN 200-52-K16-B

Measures

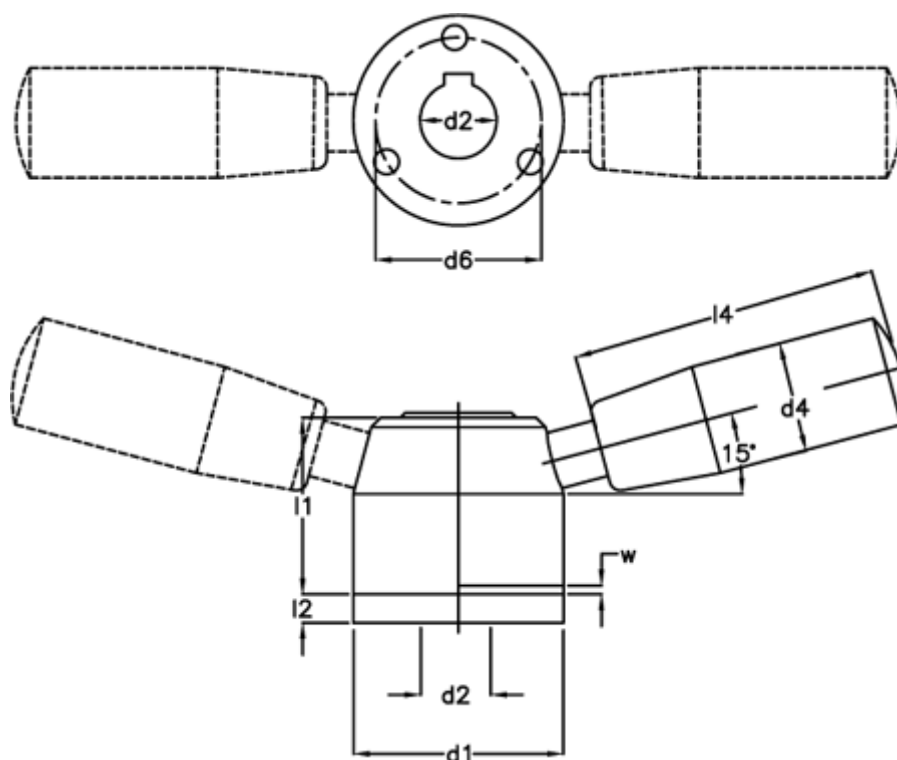

$d_1 = 52$	$l_4 = 90$
$d_2 = K16$	$W = 4$
$d_4 = 26$	
$d_5 = 31.5$	
$d_6 = 41.8$	
$l_1 = 37.5$	
$l_2 = 6$	
$l_3 = 31.5$	